

Operating Process – Work on Low Voltage or Mechanical Apparatus

Summary:

This document supports the Power System Safety Rules and its requirements assembled under Work on Low Voltage and Mechanical Apparatus – Category 4.

It applies to the operation of *Low Voltage and Mechanical Apparatus* for the purpose of issuing an access authority and subsequent restoration.

Document reference no: GD SR G2 140	Revision no: 2	TRIM NO: D2004/7796	Date: 15/12/16
Business function: Manage Health & Safety	Document type: Safety Rules Procedure		
Process owner: Manager/Health, Safety and Environment			
Author:	James Mason, Safety Rules Coordinator		
Reviewers:	Jon Workman, Safety Manager		
Approver:	Ken McCall, Manager/Health, Safety and Environment		

When referring to TransGrid's policies, frameworks, procedures or work instructions, please use the latest version published on the Wire

Table of Contents

1. Overview	4
1.1. Purpose.....	4
1.2. Policy Base	4
1.3. Reference Documents	4
1.4. Scope.....	4
1.5. Accountability	4
1.6. Document Location.....	5
2. Operating Requirements.....	5
2.1. Introduction	5
2.2. Requirements to make Low Voltage and Mechanical Apparatus Safe for Work	5
2.3. Using Low Voltage and Mechanical Preparation and Restoration Instructions	6
3. Operating Process.....	7
3.1. On arrival to site	8
3.2. Preparation.....	8
3.3. Access Authority Issue and Cancellation.....	9
3.4. Restoration.....	9
4. Not used.....	10
5. Tags and Labels.....	10
5.1. Do Not Operate Tags and Warning tags	10
5.1.1. Obsolete Do Not Operate Tags or Warning tags.....	10
5.2. Control Inhibit Tags.....	10
5.3. Not used.....	10
5.4. Tagging of LV or Mechanical Apparatus.....	10
5.4.1. General	10
5.4.2. No operation of apparatus required for work	10
5.4.3. Operation of apparatus IS required, but NOT at start of work	11
5.4.4. Operation of apparatus IS required at start of work	11
5.4.5. Control system isolations.....	11
6. Electrical Operating Work	11
6.1. De-energising, Isolating and Proving De-energised Exposed Conductors.....	12
6.2. Protection Isolations	12
6.2.1. Protection isolations delegated to protection staff	13
6.3. Transformer Automatic Voltage Control Equipment.....	13
6.4. Pilot Cables	13
7. Mechanical Operating Work.....	13
7.1. Preparation of Mechanical Apparatus for Work	14

7.2. Methods of Isolating Mechanical Apparatus	14
7.2.1. Isolation Requirements.....	14
7.2.2. Methods of Isolation from Moving Parts	15
7.2.3. Methods of Isolation from Substances through Piping.....	16
8. Definitions	17
9. Change history	18
10. Implementation.....	18
11. Monitoring and Review	19
12. Attachments	19
Attachment 1 – Preparation of Low Voltage/Mechanical PRI	20
Attachment 2 – LVMPRI Template - Preparation.....	21
Attachment 3 – LVMPRI Template - Restoration	22

1. Overview

1.1. Purpose

This document supports the Power System Safety Rules and its requirements assembled under Work on Low Voltage and Mechanical Apparatus – Category 4.

1.2. Policy Base

Document No.	Document
GD SR G1 100	Power System Safety Rules

1.3. Reference Documents

Document No.	Document
GD SR G2 141	Access for Work on Low Voltage and Mechanical Apparatus
GD SR G3 142	Safe Work Practices on Low Voltage and Mechanical Apparatus
GM AS P2 001	Isolation and Restoration of Protection and Metering Equipment

1.4. Scope

The process applies to the operation of *Low Voltage and Mechanical Apparatus* for the purpose of issuing an access authority and subsequent restoration.

1.5. Accountability

Responsible person	Responsibility
Manager/Health, Safety and Environment	Maintenance and ownership of this standard
Mgr – Training	Implementation of training programs associated with this standard
Authorised persons	Comply with this standard

1.6. Document Location

Block diagram showing relationship to other documents

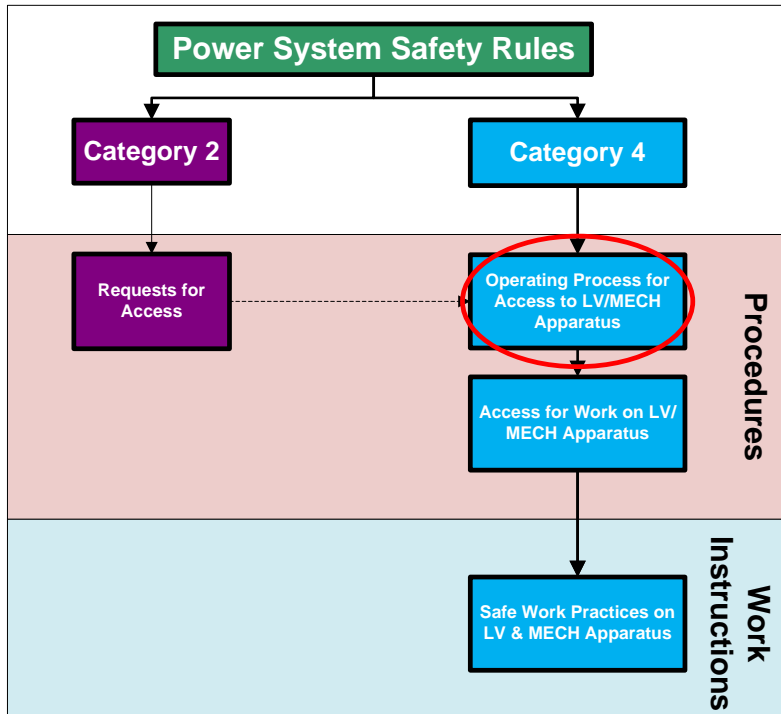

2. Operating Requirements

2.1. Introduction

The operation of *Low Voltage and Mechanical Apparatus* maybe required for the purpose of issuing a Low Voltage or Mechanical (LV/MECH) Access Authority.

The sections within this document cover the generic sequence required to safely prepare *Low Voltage or Mechanical Apparatus* ready for the issue of a LV/MECH Access Authority and the generic restoration sequence required after cancellation of a LV/MECH Access Authority.

This document also covers general operating requirements for logging, tagging and locking of *Low Voltage and Mechanical Apparatus*.

This document should be read in conjunction with the 'Access for Work on *Low Voltage and Mechanical Apparatus*' and 'Access for Work on HV Apparatus', which cover the issue and cancellation of Access Authorities.

2.2. Requirements to make Low Voltage and Mechanical Apparatus Safe for Work

Low Voltage and Mechanical Apparatus is made ready for work by use of a Low Voltage Mechanical Preparation and Restoration Instruction (LVMPRI) to ensure safe work conditions are in place before any Access Authorities are issued and work commences.

LVMPRI will include specific instructions for:

- (a) Isolation of the *Low Voltage and Mechanical Apparatus* including affixing tags and locking open of points of isolation where relevant.
- (b) Verifying that the low voltage conductors have been de-energised; and
- (c) Earthing of the low voltage conductors.

For information on the preparation of LVMPRI's consult: Attachment 1 - Preparation of LVMPRI's.

2.3. Using Low Voltage and Mechanical Preparation and Restoration Instructions

Low Voltage and Mechanical Preparation and Restoration Instructions (LVMPRI) detail operating steps to carry out Low Voltage and Mechanical Operating Work.

Each operating step requires the following method to be applied:

1. Read the LVMPRI step;
2. Take the LVMPRI to the point of operation;
3. Check the equipment description against the LVMPRI;
4. Prepare to perform the required actions;
5. Check again the equipment description and required actions against the LVMPRI;
6. Perform the required actions;
7. Check device has operated and all actions completed correctly; and
8. Cross off the step in the LVMPRI.

Such LVMPRI's shall be listed in the Warning and Hazard Assessment Form for the work.

3. Operating Process

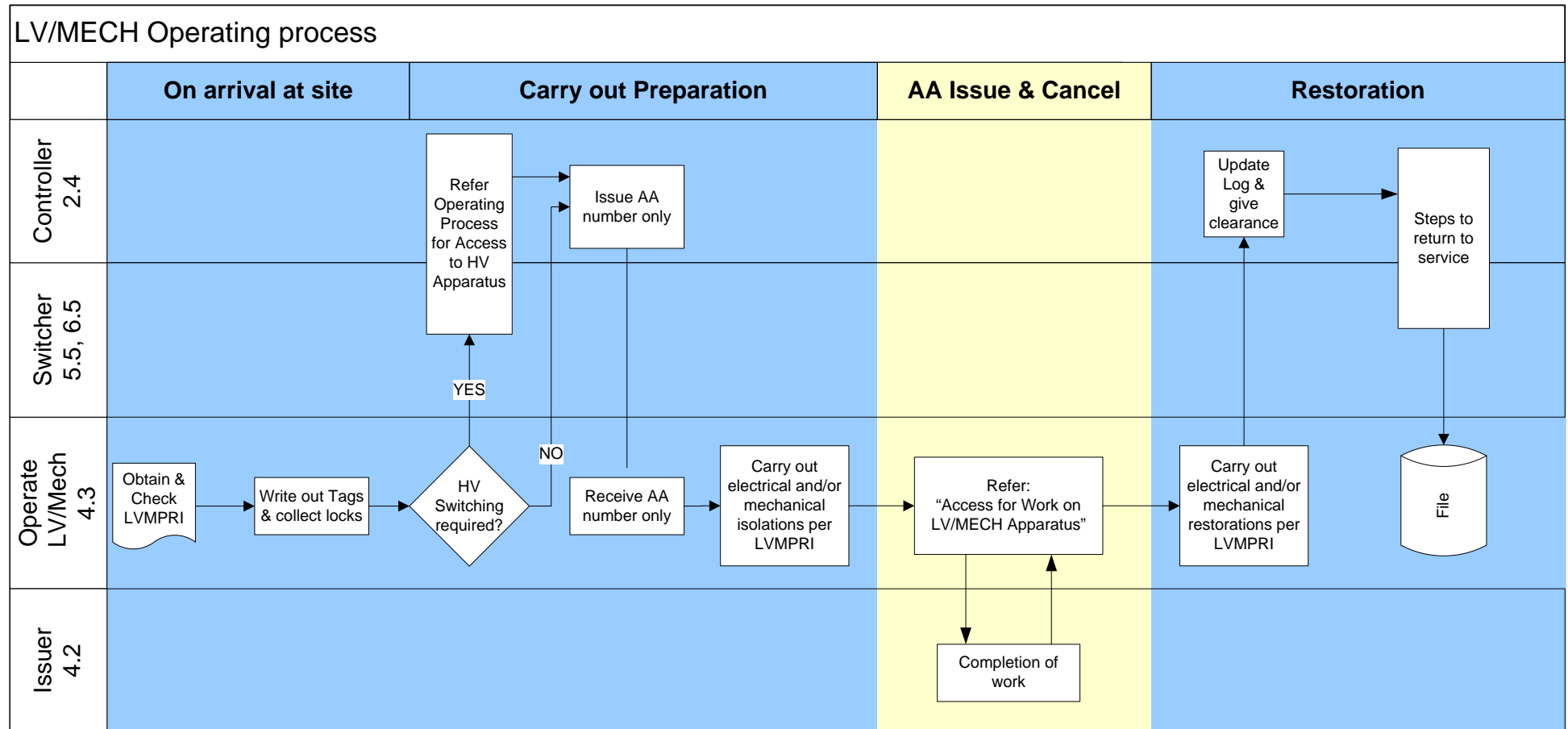

NOTE: This process is a generic sequence. Some sites have specific requirements, which can be found in the relevant substation OM's.

3.1. On arrival to site

The LV/MECH operator shall follow the generic steps listed below:

Step	Safety Rules Authorisation	Task	Comments	Reference Document
1	4.3	Obtain LVMPRI or PMWI and ensure collation is correct	Isolations may be performed by either LVMPRI or PMWI	Attachment 1 & 2
2	4.3	Check RFA matches LVMPRI		
3	4.3	Check LVMPRI sequence against work requested		
4	4.3	Operator to notify controller that they are onsite		
5	4.3	Write out required Tags (Do Not Operate or Warning tags)	Ensure correct information is written on Tags.	
6	4.3	Collect O1 locks if required		
7	4.3	Check if HVPRI is required	Follow - Operating Process for Access to HV Substation Apparatus	GD SR G2 150

3.2. Preparation

Step	Safety Rules Authorisation	Task	Comments	Reference Document
1	4.3	Receive AA number from controller		
2	4.3	Receive clearance from controller to carry out LVMPRI or PMWI		
3	4.3	Follow steps of LVMPRI	Cross out steps as completed with a non-obliterating line. Depending on the type of equipment, operating sequences will vary.	

3.3. Access Authority Issue and Cancellation

Apparatus	Safety Rules Authorisation	Task	Comments	Reference Document
Substation LV/MECH Apparatus	4.2	Issue LV/MECH Access Authority Cancel LV/MECH Access Authority	Access for Work on LV/MECH Apparatus	GD SR G2 141

3.4. Restoration

Step	Safety Rules Authorisation	Task	Comments	Reference Document
1	4.3	Follow steps of LVMPRI	Cross out steps as completed with a non-obliterating line. Depending on the type of equipment, operating sequences will vary.	
2	4.3	Advise Controller that steps of LVMPRI complete		
3	5.5	Receive clearance from controller to carry out HVPRI restoration if required	Follow - Operating Process for Access to HV Substation Apparatus	GD SR G2 150
4	4.3, 5.5	File 'used PRI' and associated documentation in designated filing cabinet.		

4. Not used

5. Tags and Labels

Tags and labels are used to indicate temporary abnormal conditions of apparatus. Printed tags and labels are physically attached to equipment whereas electronic tags associated with supervisory systems (SCADA and HMI etc) are graphic symbols shown adjacent to a device on the display.

The following tags and labels are in use:

- Do Not Operate Tag (DT)
- Warning tag (WT)
- Control Inhibited Tag (CIT)

5.1. Do Not Operate Tags and Warning tags

Use of DTs and WTs is controlled because they are part of the process to set up safe working conditions on or near high voltage, low voltage and mechanical apparatus in the charge of the Controller. Application and removal of DTs and WTs in this circumstance shall only be carried out by a person authorised PSSR Category 4.3, 5.5, 5.6 or 6.5.

- **Do Not Operate Tag** - PROHIBITS personnel from operating any device switch, control, valve, link etc., to which it is attached.
- **Warning Tag** allows LIMITED OPERATION of the device or control to which it is attached, to the extent indicated on the tag.

5.1.1. Obsolete Do Not Operate Tags or Warning tags

- a) If a DT or WT is found attached to apparatus which is required to be operated, and it is likely that the tag is obsolete the matter shall be investigated by the Controller, who shall establish from records of Access Authorities whether the tag is no longer applicable and can be removed.

5.2. Control Inhibit Tags

Where supervisory control is provided, an electronic Control Inhibit Tag (CIT) shall be used in lieu of a paper tag as part of the safe working conditions established when work is required on or near HV apparatus or for security of the system. The application of a CIT prevents supervisory control of the device.

5.3. Not used

5.4. Tagging of LV or Mechanical Apparatus

5.4.1. General

In cases where links or fuses are identified as a group, one Do Not Operate Tag or Warning tag may be used to cover the group. In the case where control points, mechanical charging points and isolation points are located inside a cabinet, one tag may be applied to the closed door to cover those items and where a Do Not Operate Tag is used the door(s) are to be locked if practical.

5.4.2. No operation of apparatus required for work

If there is no requirement for the operation of the apparatus by the person holding the Access Authority, then the PRI shall have steps for Do Not Operate Tags to be applied to all points of isolation.

5.4.3. Operation of apparatus IS required, but NOT at start of work

The PRI shall have steps for Warning tags to be applied to points of low voltage or mechanical isolation that may be restored during the course of the work and to all control points that are able to operate the apparatus during an operational test. Such Warning tags shall be endorsed with the number of the PRI under which they were affixed and the number of the associated Access Authority.

Warning tags should also be endorsed, in the space headed "Comments", with any special instructions or conditions applicable to the restoration of the isolation, or operation of the control.

5.4.4. Operation of apparatus IS required at start of work

Warning tags shall be applied to isolation points of hazardous LV or Mechanical apparatus that may be altered during the course of the work and to all control points from which it is possible to operate the apparatus during the test. Such Warning tags shall be endorsed with the number of the PRI under which they were affixed and the number of the associated Access Authority.

Warning tags should also be endorsed, in the space headed "Comments", with any special instructions or conditions applicable to the restoration of the isolation, or operation of the control.

5.4.5. Control system isolations

If it is necessary to open a control supply link associated with SCADA or other remote control at an electrical station to prevent remote operation of HV apparatus, then the point of isolation shall be tagged. Should operational checks of the supervisory function be required during the work, Warning tags shall be applied to the open link(s). Otherwise, a Do Not Operate tag shall be applied to each point of isolation.

Appropriate tagging shall also be carried out at the remote end.

6. Electrical Operating Work

Electrical operating work is the operation of switching devices, links, fuses, or other connections intended for ready removal or replacement, proving conductors de-energised, locking and tagging of electrical apparatus and the erection of barriers and signs.

When electrical operating work is carried out on apparatus in the charge a Controller steps shall be detailed in Low Voltage/ Mechanical Preparation and Restoration Instruction (LVMPRI).

The preparation and restoration of mechanical apparatus shall be carried out in accordance with the following:

- (a) Electrical operating work is only carried out by a person authorised category 4.3;
- (b) Electrical operating work on apparatus in the charge of a Controller be carried out at the direction of the Controller;
- (c) Isolation of electrical apparatus is carried out in accordance with section 6.1 - De-energising, Isolating and Proving De-energised Exposed Conductors;
- (d) In emergency circumstances involving danger to life or risk of damage to apparatus, electrical operating work and/or other appropriate emergency operations shall be carried out in accordance with approved procedures provided the person carrying out the emergency operations considers it safe to do so. The Controller shall be advised of the emergency circumstances and of the emergency operations undertaken as soon as practicable.
- (e) Electrical apparatus shall not be energised or re-energised unless:
 - i. All relevant Access Authorities are cancelled and all persons are clear;

- ii. It is in a state suitable for energisation;
- iii. All earths, bonds, bridges, equipment, plant, tools and materials are removed as appropriate;
- iv. Appropriate checks and tests are carried out to ensure apparatus is safe for service; and
- v. Approval is given from the Controller to energise or re-energise.

6.1. De-energising, Isolating and Proving De-energised Exposed Conductors

Authorised persons shall ensure the following steps for making the work safe are undertaken:

- (a) Identify the equipment to be worked on and the appropriate isolation or de-energising points;
- (b) Make and secure the isolations.

The authorised person shall apply a Warning tag or do not operate tag to the point of isolation/de-energisation. The Warning tag or do not operate tag shall include the name of the person who attached the tag and any appropriate comments relating to the work to be carried out.

If isolation is not possible (in addition to the de-energisation) then the point of de-energisation must be tagged and locked where possible, or otherwise secured in the open position and proven de-energised at the point of work to ensure that the circuit is de-energised.

If both a point of de-energisation and a point of isolation have been provided, one of these points must be tagged and locked where possible or otherwise secured in the open position to prevent its inadvertent operation.

Note, for work on ELV do not operate /Warning tags need only to be applied when the pre work risk assessment determines it is appropriate to do so.

- (c) Prove de-energised at the point of work.

Test equipment used to prove conductors de-energised is to be proven on a known source immediately before and after the test.

- (d) Identify the safe area of work as appropriate.

- (e) On the completion of the work, all tags shall be removed by the authorised person or the authorised person withdrawing the access authority to work as appropriate.

However, if the work is incomplete, the authorised person shall ensure that the Warning tag or do not operate tag indicates whether the equipment is unserviceable/serviceable and is endorsed with any special conditions that may apply.

In the event of a Warning tag or do not operate tag being left on equipment and the person who placed the warning or Do Not Operate tag cannot be contacted then two appropriately authorised persons may authorise the removal of the Warning tag or do not operate tag after assessing that it is safe to do so.

6.2. Protection Isolations

The required protection isolations shall be detailed in the PRI for the outage except as allowed in 6.2.1 (a) and (b). Protection isolations not covered as steps in a PRI shall be carried out using the appropriate Protection and Metering Withdrawal Instruction (PMWI). A copy of the PMWI should be forwarded to operating staff for information purposes.

6.2.1. Protection isolations delegated to protection staff

When work on protection equipment is to be done by protection staff (staff authorised by Manager Technical Services) they may be assigned the responsibility for performing protection isolations subject to the criteria and associated actions in part (a) and (b) below.

- (a) When no other working party's safety relies on circuit breakers or unit protection associated with the protection being worked on.

Where this criteria is met and responsibility for LV isolations has been delegated to protection staff, such isolations shall be carried out using the relevant PMWI, after receiving an Access Authority and before commencing the designated work.

- (b) Where protection isolations have been included as steps in the PRI, additional protection isolation or restoration steps required for protection work may be carried out by the protection technician as part of their work, provided any proposed alterations to the isolations will not conflict with system security or the safety of any other work party.

In this situation, the controller shall advise the protection technician, prior to the issue of an Access Authority, of any protection links previously opened in any relevant PRI. The protection technician shall list or reference these previously opened links on the Access Authority and on the PMWI. The protection technician shall carry out additional isolations using the relevant PMWI after receiving an Access Authority and before commencing the designated work.

6.3. Transformer Automatic Voltage Control Equipment

When an outage requires the AVC on a transformer to be taken out of service, this shall be done by a person authorised category 5.5 who will be responsible for maintaining the busbar voltage by manual control, as directed by the controller. .

The equipment shall be returned to automatic on completion of the work, as directed by the controller.

6.4. Pilot Cables

An RFA shall be submitted when work is to be performed on pilot cores carrying signals associated with:

- System security such as protection intertrips;
- System monitoring and control such as SCADA transmissions;
- Important telephone circuits.

Work by distributor staff on customer or joint use pilot cables requires the issue of an Access Authority for Test in accordance with the distributor's Electrical Safety Rules. As such, co-ordination of outages will be required as set out in OM 908 and a verbal clearance will be required from TransGrid's Controller.

All work by TransGrid staff on low voltage and mechanical insulated cables shall be carried out in accordance with the procedures set out in ['Safe Work Practices on HV Cables' GD SR G3 172](#).

7. Mechanical Operating Work

Mechanical operating work is the operation of devices that control sources of energy and the implementation of control measures to prevent the unintentional release of that energy.

When mechanical operating work is carried out on apparatus in the charge a Controller steps shall be detailed in Low Voltage/ Mechanical Preparation and Restoration Instruction (LVMPRI).

The preparation and restoration of mechanical apparatus shall be carried out in accordance with the following:

- (a) Mechanical operating work is only carried out by a person authorised category 4.3;
- (b) Mechanical operating work on apparatus in the charge of a Controller be carried out at the direction of the Controller;
- (c) Isolation of mechanical apparatus is carried out in accordance with section 7.2 - Methods of Isolating Mechanical Apparatus;
- (d) In emergency circumstances involving danger to life or risk of damage to apparatus, mechanical operating work and/or other appropriate emergency operations shall be carried out in accordance with approved procedures provided the person carrying out the emergency operations considers it safe to do so. The controller shall be advised of the emergency circumstances and of the emergency operations undertaken as soon as practicable.
- (e) Mechanical apparatus shall not be energised or re-energised unless:
 - i. All relevant access authorities are cancelled and all persons are clear;
 - ii. It is in a state suitable for energisation;
 - iii. All mechanical restraints, equipment, plant, tools and materials are removed as appropriate;
 - iv. Appropriate checks and tests are carried out to ensure apparatus is safe for service; and
 - v. Approval is given from the Controller to energise or re-energise.

7.1. Preparation of Mechanical Apparatus for Work

- (a) When work is to be performed on mechanical apparatus all materials, substances, agents or conditions that pose a risk to the health and safety of the persons required to work on the mechanical apparatus shall be isolated.
- (b) Control measures taken to isolate mechanical apparatus shall:
 - i. Prevent the activation or energising of apparatus or services including secondary sources of energy that are likely to adversely cause the activation or energising of the mechanical apparatus;
 - ii. Ensure, if required, the mechanical apparatus is unwound, un-tensioned or drained, vented and depressurised;
 - iii. Prevent the introduction of materials or substances through equipment such as piping, ducts, vents, drains, conveyors, service pipes;
 - iv. Prevent the uncontrolled movement or rotation of the mechanical apparatus;
 - v. Ensure, where practicable, that the devices isolating the mechanical apparatus are tagged and secured; and
 - vi. Remain in place until all persons working under the authority have signed off.

7.2. Methods of Isolating Mechanical Apparatus

7.2.1. Isolation Requirements

When persons are required to work on mechanical apparatus all materials, substances, agents or conditions harmful to persons should be isolated and rendered inoperable to prevent the activation or energisation of mechanical apparatus or services which could pose a risk to the health and safety to such persons.

Isolation measures such as tagging and, where practicable, securing the isolation should be supervised or verified by the authorised person in charge or those persons having immediate control of the work. Isolation measures should not be removed until all persons who have worked on the apparatus have been notified that the work is complete and the isolation is to be removed.

7.2.2. Methods of Isolation from Moving Parts

Before work is permitted on any mechanical apparatus which has the potential to move, or in which agitators, fans or other moving parts that pose a risk to persons are present the possibility of movement should be prevented. Isolation procedures should ensure that movement is prevented by the relevant method described below or by approved alternative methods affording an equivalent level of safety.

- (a) Equipment or devices with stored energy, including hydraulic, pneumatic, chemical, mechanical, thermal or other types of energy, should be reduced to a zero energy state. Where shafts, agitators, blades and other moving equipment are involved, then the risk of their free movement should be taken into account, and control measures such as chocking, wedging, chaining or removal of these parts considered. A warning of the stored energy and its status at the time of commencement of work, such as charged or discharged, should be included on the Access Authority Warning and Hazard Assessment Form.

- (b) Positive steps should be taken to achieve de-energisation, tagging and, where practicable, securing of machinery, agitators or other apparatus containing moving parts. This could require additional isolation, blocking or de-energising of the mechanical apparatus itself to guard against the release of stored energy. An example is the stored energy of springs.

Such positive steps include:

- i. Operation of the circuit breaker to remove all stored energy;
- ii. Tagging and, where practicable, a means of securing should be placed on the open circuit breaker or open isolating switch supplying electric power to the mechanical apparatus with hazardous moving parts.
- iii. Where a power source cannot be controlled readily or effectively, a belt or other mechanical linkage should be disconnected and tagged to indicate the belt or linkage should not be reconnected until all work on the apparatus has been completed. When the removal of electrical components, such as fuses, is used as a means of isolation, then the electrical component should be removed and the circuit tagged. Circuits should always be tested to ensure isolation is effective;
- iv. Moveable components should be tagged and, where practicable, secured and switches, clutches or other controls should be tagged to indicate that the tags and securing devices should not be removed until the work has been completed; and
- v. Secondary control circuits should be isolated by the removal of fuses or links, or the opening of circuit breakers, where appropriate.

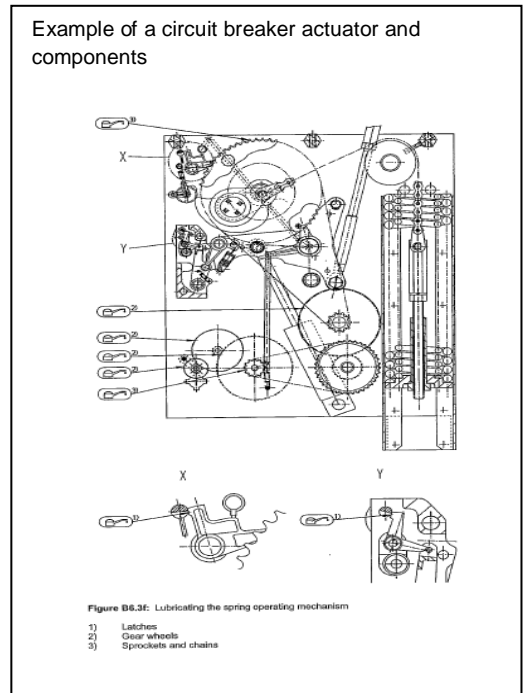

7.2.3. Methods of Isolation from Substances through Piping

Piping isolation prevents the introduction of materials or substances through equipment such as piping, ducts, vents, drains, and service pipes.

The methods of isolation of piping should be in accordance with one of the methods described below or by an approved alternative method affording an equivalent level of safety:

- (a) Removal of a valve, spool piece, an expansion joint in piping leading to, and as close as practicable to, the work and blanking or capping the open end of the piping. The blank or cap should be identified to indicate its purpose. Blanks or caps should be of a material that is compatible with the liquid, vapour or gas with which they are in contact. The material should also have sufficient strength to withstand the maximum operating conditions such as

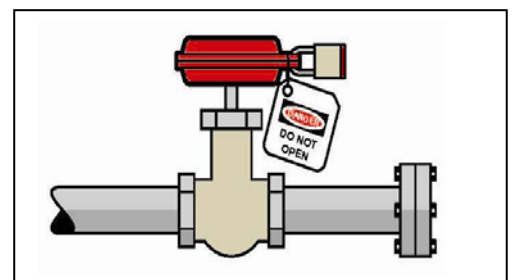

pressure, temperature and surges, which may occur in the piping; or

- (b) Insertion of a suitable full-pressure spade (blank) in piping between the flanges as close as practicable to the work. The full pressure spade (blank) should be identified to indicate its purpose; or

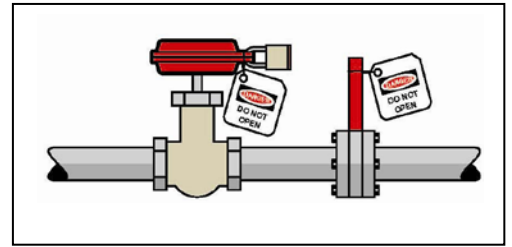

- (c) Isolation by means of closing, tagging and, where practicable, securing (or both), of valves in the piping associated with the apparatus. A drain valve between the two closed valves should also be tagged and, where practicable, secured (or both) as part of this method.

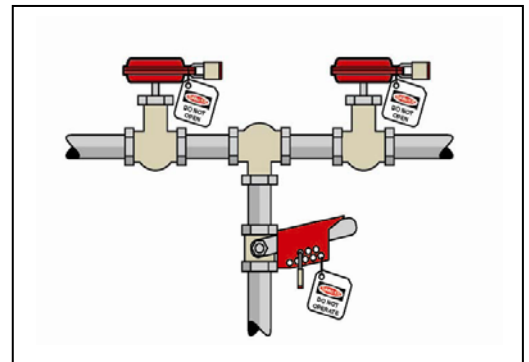

NOTE: Where no pressure indicators have been installed in blanked-off pipe sections, consideration should be given to the possibility of pressure build-up occurring during the blanked-off time.

8. Definitions

Term	Definition
<p><i>Low Voltage and Mechanical Apparatus</i></p>	<p>Apparatus that falls within the scope of Apparatus in the Charge of a Controller per Safety Rule 4.1. Such apparatus could affect operation of the HV system because:</p> <ul style="list-style-type: none"> (a) It is capable of causing operation of HV apparatus (for example: trip or prevent tripping of circuit breakers). (b) It could affect the operation of HV apparatus (for example: cause or prevent tap changing of transformer); (c) It requires an outage of HV apparatus for safety of staff. This includes situations where work is to be carried out under an Access Authority on low voltage/mechanical apparatus, but access to high voltage exposed conductors is not required. <p>LV or mechanical apparatus includes the following equipment where such equipment affects the operation of the high voltage system or operating facilities:-</p> <ul style="list-style-type: none"> • Alarm and metering circuits and equipment • Automatic generation control (AGC) equipment • Load shedding equipment of any description • Automatic voltage control equipment (on generating units, synchronous condensers, transformers and static compensators) • Auxiliary transformers and auxiliary supplies

	<ul style="list-style-type: none"> • Fire protection equipment associated with HV apparatus or LV apparatus • Intertrip protection signalling equipment • LV or mechanical apparatus requiring HV apparatus out of service to provide personal safety requirements for the LV or mechanical work • LV or mechanical apparatus, which, if withdrawn from service, would preclude the associated HV apparatus staying in service • Protection relays and associated circuitry • Signalling controls instrumental to the operation of HV or LV apparatus • Supervisory control and monitoring equipment of any description (LCSS, SCADA, EMS etc) • Equipment associated with provision of sustained auxiliary supplies • HV equipment ancillary apparatus such as: cooling system fans and pumps; tap changer motors; performance monitoring facilities etc. <p>Any other <i>Low Voltage or Mechanical Apparatus</i> is regarded as apparatus not in the charge of a controller and for which Safety Rule Section 3 applies and is outside the scope of this instruction.</p> <p>If unsure of whether LV apparatus falls into the category of being in the charge of a controller, contact System Operations staff for clarification.</p>
--	--

9. Change history

Revision no	Approved by	Amendment
0	Lionel Smyth, EGM/NS&O	Replaces in part documents 'Operating Requirements – General' GD SR G2 005; Operating Requirements - Work On System Low Voltage Or Mechanical Apparatus - GD SR G2 012; and 'Operating Requirements - Local Safety Precautions' GD SR G2 007.
1	Ken McCall, Manager/HSE	This procedure has been reviewed and reissued with no changes.
2	Ken McCall, Manager/HSE	Section 4 deleted Section 5 summarised in line with other PSSR documents Section 5.4.4 "Operation of apparatus IS required at start of work" revised to remove option of not carrying out LVMPRI Attachments 2 & 3 updated to current templates

10. Implementation

This procedure is to be implemented in conjunction with the implementation of TransGrid's Power System Safety Rules. It will be available as a resource, published on the Wire.

11. Monitoring and Review

The Manager/Health, Safety and Environment is responsible for the ongoing monitoring and review of the documents associated with the Power System Safety Rules. This can include but is not limited to:

- (a) Requesting regular feedback on the effectiveness of procedures and work instructions. Appropriate feedback tools include focus groups and online assessments;
- (b) Where a change has occurred in our processes; and
- (c) Recommendations arising from incidents.

12. Attachments

Attachment 1 – Preparation of Low Voltage/Mechanical PRI

Attachment 2 – LVMPRI Template - Preparation

Attachment 3 – LVMPRI Template - Restoration

Attachment 1 – Preparation of Low Voltage/Mechanical PRI

The Low Voltage/Mechanical Preparation and Restoration Instruction (LVMPRI) provides the step-by-step procedure required to be followed in order to prepare the identified LV or mechanical apparatus for access and restore the apparatus to service.

The isolation requirements for *Low Voltage or Mechanical Apparatus* will be derived from the relevant Request for Access (RFA).

The LVMPRI number is to have the format: (associated RFA No.) / (Sequence No.) eg:

If there will be two LVMPRI's to be carried out for RFA No. 561, the first LVMPRI will be 561/1 and the second LVMPRI will be 561/2. The LVMPRI No. shall be used on the associated Do Not Operate Tags and Warning tags.

The LVMPRI shall:

- (a) Be prepared using the template included in Attachment 2 and 3;
- (b) Be prepared and checked by two independent persons authorised category 4.3;
- (c) Nominate each device or item of equipment that is to be tagged and the required status of the device;
- (d) Specify the type of tag whenever a tag is to be applied;
- (e) Include steps to prove the integrity of the isolation e.g. proving de-energised;
- (f) Include, if required, steps to cover the exchange of operating clearances from other operating groups; and
- (g) Include details of warnings when required e.g. Take Local Safety Precautions as per Power System Safety Rules.

LVMPRI templates are available to authorised users at <http://thewire/projects/LVMPRI/Pages/default.aspx>

Attachment 2 – LVMPRI Template - Preparation

Where planned work requires the use of a LVMPRI, the instruction shall be prepared using the template available on the LVMPRI sharepoint, example below

LVMPRI No. _____ / _____







Prepared by: [Prepared by] Checked by: [Checked by] Date: [Date]
 Location: TPL Equip: [Ellipse ID] S Job: [STDJOB]
 Apparatus: [Title] Type: [Model]
 Scope: Operation of apparatus IS required, but NOT at start of work
 Drawings: [Ref Drawings]

LV/MECH Preparation

SAFETY	LV insulated gloves shall be used for highlighted steps	
1.	IMSAFE (Illness, Medication, Stress, Alcohol, Fatigue, Emotion)	IMSAFE Check Completed

Location: BAY MARSHALLING KIOSK (2Af)				
Step	Item	Link/Fuse ID	Action	Tag
2.	GPO/Heater Supply Fuse	FSXX	Remove carrier Fuse cartridge(s) removed Empty carrier reinserted	-
3.	Motor Supply Fuses (2)	FS105, 101	Remove	-
4.	Marshalling Kiosk doors		Close doors, apply tags	 x2

Location: CB Control Cabinet				
Step	Item	Link/Fuse ID	Action	Tag
5.	GPO/Heater		Prove de-energised	-
6.	Motor Starter switch		Switch off	-
7.	CB Close & Trip buttons		Close & Trip to de-energise springs	-
8.	Motor Supply Links (2)	MOTOR 1, 2	Remove	-
9.	No.1 & No.2 TRIP Isolating Links (4)	UM1, 2, 3, 4	Remove	-
10.	CLOSE Isolating Links (2)	TM1, 2	Remove	-
11.	Control cabinet doors		Close doors, apply tags	 x2
12.	Mechanical TRIP button		Apply tag	

Location: MCB BUILDING NO.1 TRANSFORMER CONTROL CUBICLE 15				
Step	Item	Link/Fuse ID	Action	Tag
13.	CDS CB4412B		Apply tag	
14.	DC Supply Fuses (4)	FS01, 02, 03, 04	Nil	-
15.	DC Supply Links (2)	LK33, 34	Nil	-
16.	Trip & Close Links (3)	LK01, 02, 03	Open	-
17.	Control Cubicle 15 door		Close door, Apply tag	



Location: HMI				
Step	Item	Link/Fuse ID	Action	Tag
18.	CB4412B		Apply CIT	

Total Tags =  x8  x0

WARNINGS: AC isolated and proven de-energised. DC circuits still live.
 Residual energy after discharge – springs / nitrogen pre charge (for Hydraulic breakers)

LV/MECH Preparation completed by: _____ Date: _____

Attachment 3 – LVMPRI Template - Restoration



Where planned work requires the use of a LVMPRI, the instruction shall be prepared using the template available on the LVMPRI sharepoint, example below.

Apparatus: [Title] _____ Type: [Model]

LV/MECH Restoration



SAFETY	LV insulated gloves shall be used for highlighted steps	
1.	IMSAFE (Illness, Medication, Stress, Alcohol, Fatigue, Emotion)	IMSAFE Check Completed

Location:	HMI			
Step	Item	Link/Fuse ID	Action	Tag
2.	CB4412B		Remove CIT	

Location:	MCB BUILDING NO.1 TRANSFORMER CONTROL CUBICLE 15			
Step	Item	Link/Fuse ID	Action	Tag
3.	Control Cubicle 15 door		Remove tag	
4.	DC Supply Fuses (4)	FS01, 02, 03, 04	Check restored or restore	-
5.	DC Supply Links (2)	LK33, 34	Check closed or close	-
6.	Trip & Close Links (3)	LK01, 02, 03	Check closed or close	-
7.	CDS CB4412B		Remove tag	

Location:	BAY MARSHALLING KIOSK (2Af)			
Step	Item	Link/Fuse ID	Action	Tag
8.	Marshalling Kiosk doors		Remove tags	 x2
9.	Motor Supply Fuses (2)	FS105, 101	Check restored or restore	-
10.	GPO/Heater Supply Fuse	FSXX	Check restored or restore	-

+/-

Location:	CB Control Cabinet			
Step	Item	Link/Fuse ID	Action	Tag
11.	Mechanical TRIP button		Remove tag	
12.	Control cabinet door		Remove tags	 x2
13.	No.1 & No.2 TRIP Isolating Links (4)	UM1, 2, 3, 4	Check restored or restore	-
14.	CLOSE Isolating Links (2)	TM1, 2	Check restored or restore	-
15.	Motor Supply Links (2)	MOTOR 1, 2	Check restored or restore	-
16.	Motor Starter switch		Check reset or reset, confirm springs charge	-

Total Tags =  x8

LV/MECH Restoration completed by: _____ Date: _____